

High precision tool for great surface finishing

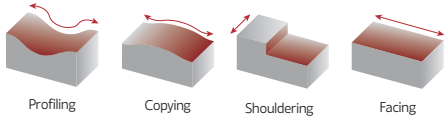

W-PRO
62090

NEW



INSERT SIZE
08 | 10 | 12
16 | 20 WCR

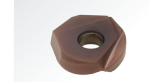

NEW

INSERT SIZE
08 | 10 | 12
16 | 20 WCL

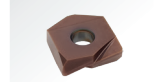

NEW

SINCE 1916

NEW W-PRO 62090 - NEW GRADE PHH

NEW

Nova linha W-PRO 62090 - Novo grau PHH | Nueva línea W-PRO 62090 - Nueva calidad PHH

The new W-PRO is the combination of the most refined inserts and the most stable shanks. When looking for a finishing solution for Steels, Stainless Steels, Cast Irons, HRSA or Hardened Steels that can work for a long time while delivering a flawless machined surface, this is the best solution.



Carbide shank in order to reduce vibrations

Maximum runout of 0.02 mm is achieved by a high accuracy mounting

WCL

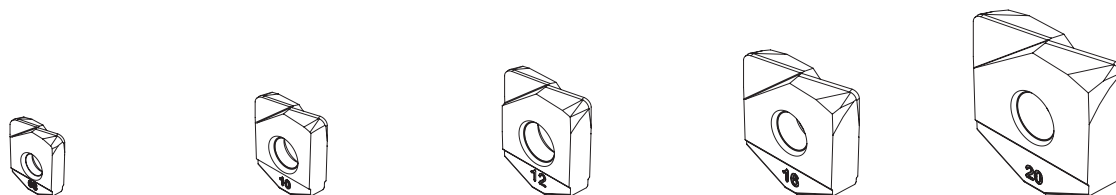

WCR

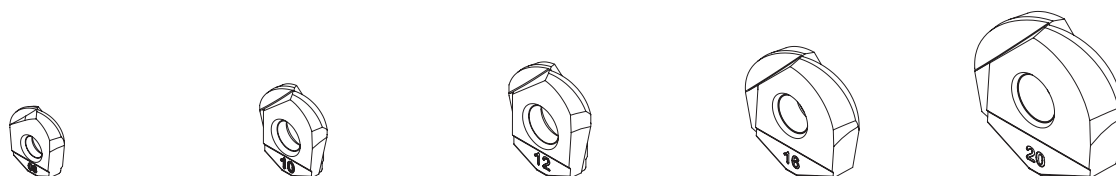

One toolholder for two types of inserts

NEW W-PRO 62090 = NEW GRADE PHH

NEW

Nova linha W-PRO 62090 - Novo grau PHH | Nueva línea W-PRO 62090 - Nueva calidad PHH

PHH GRADE = PVD grade

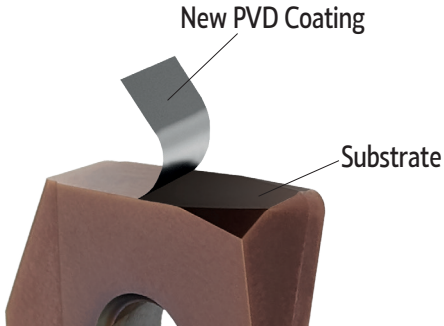

This new coating has a very high thermal stability and provides long tool life.

For applications in machining of hardened steels, stainless steels and titanium alloys.

This new coating achieves an unmatched balance between high hardness and thermal stability. It is the perfect coating for machining hardened material.

P - STEEL

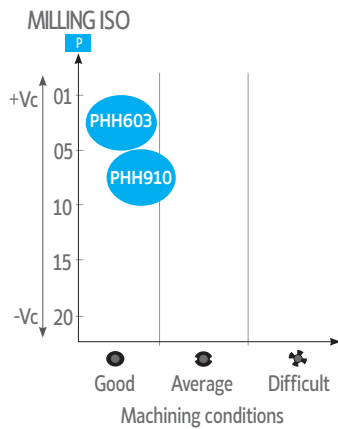

M - STAINLESS STEEL

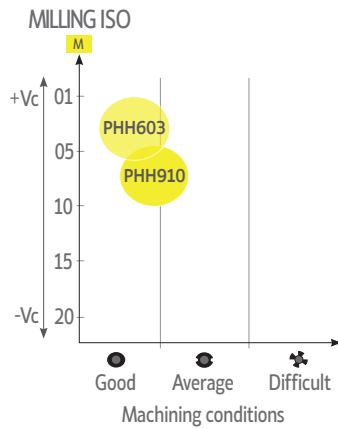

K - CAST IRON

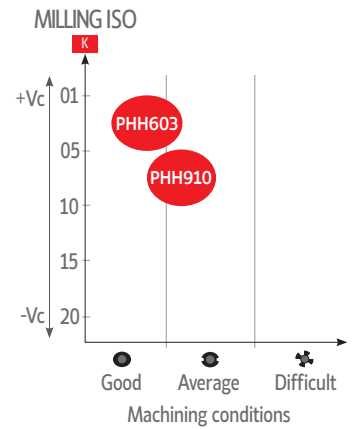

S - HEAT RESISTANT / TITANIUM ALLOYS

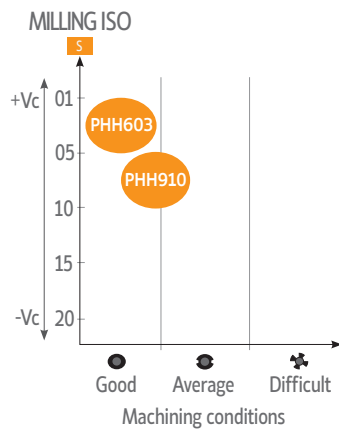

H - HARDENED MATERIALS

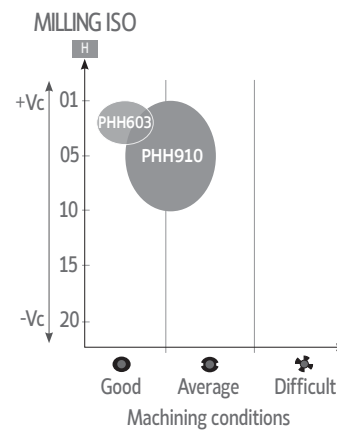

NEW W-PRO 62090 - NEW INSERTS WCR | WCL

NEW

Nova linha W-PRO 62090 - Novas pastilhas WCR - WCL | Nueva línea W-PRO 62090 - Nuevas plaquitas WCR - WCL

WCR | WCL

P M K S H

INSERT SIZE
08 | 10 | 12
16 | 20

WCR
WCL

WCR



WCL



NEW

WCR

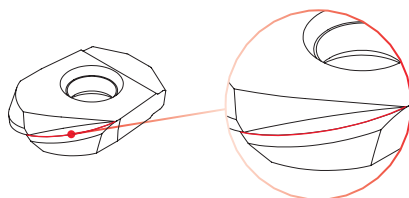
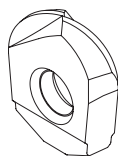
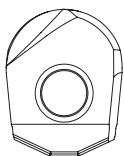

Helical profile
for smooth cutting

WCL

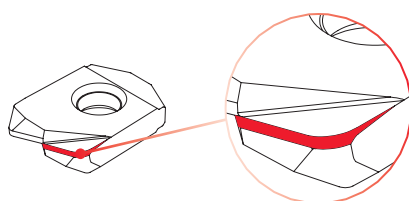
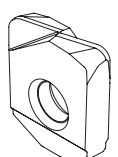
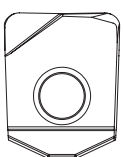

Reinforced
cutting edge

- Tight Insert tolerances;
- Reduced cutting forces due to a high helix angle shape, resulting in a smoother machining with less vibration.

PROCEDURES FOR CLAMPING SCREWS

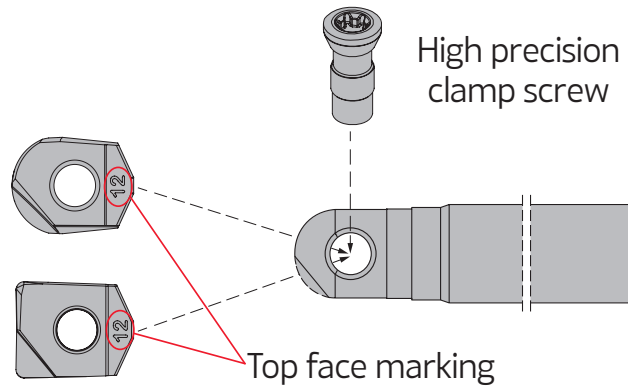

1. Check the insert seat.

Before assembly cutter it is important to ensure that the insert seat has not been damaged during machining or handling.

2. Clean the insert seat.

Make sure that the insert seat is free from dust or chips from previous machining. If necessary, clean the insert seat with pressurised air.

3. Position the insert.

Position the insert with the top face marking in the direction of screw placement and couple the insert into the cutter.

4. Lubricate the insert screw.

Apply sufficient screw lubrication to prevent seizure. Lubricant should be applied in small quantity to the screw threads.

5. Always use a torque wrench to ensure that screws are correctly tightened (please confirm torque data). Excessive torque will negatively affect the performance of the tool and can cause screw and insert breakage. Uninsufficient torque leads to insert movement, vibration and degrade the cutting result. Dedicated adjustable torque wrench can be ordered separately. Please do not press down the insert during tightening process.

Note: Always replace worn or damaged screws.



Cylindrical Carbide Shank

Tolerance R	Runout Tolerance
± 0,015	R 0,02

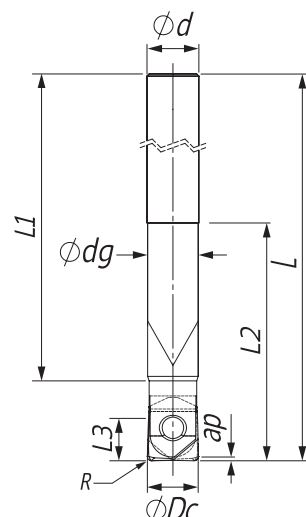

Order code Código	Reference Referência Referencia		Dimensions Dimensões Dimensiones (mm)							Kg	Specifications				Insert	Stock
			ØDc	Ød	Ødg	L	L1	L2	Ap max (mm)		Ae max (mm)	Ae max (mm)	Ae max (mm)			
181156600	008E62090-02-U008140	2	8	8	7,7	140	128	35	0,09	4,0	2,5	0,8	0,8	WCR 08.../WCL 08...		
181156700	010E62090-02-U010150	2	10	10	9,7	150	136	45	0,15	5,0	3,0	1,0	1,0	WCR 10.../WCL 10...		
181156800	010E62090-02-U010180	2	10	10	9,7	180	166	45	0,18	5,0	3,0	1,0	1,0	WCR 10.../WCL 10...		
181155700	012E62090-02-U012165	2	12	12	11,7	165	147	55	0,24	6,0	4,0	1,2	1,2	WCR 12.../WCL 12...		
181156900	012E62090-02-U012200	2	12	12	11,7	200	182	55	0,29	6,0	4,0	1,2	1,2	WCR 12.../WCL 12...		
181157000	016E62090-02-U016200	2	16	16	15,7	200	180	65	0,51	8,0	5,0	1,6	1,6	WCR 16.../WCL 16...		
181157100	016E62090-02-U016250	2	16	16	15,7	250	230	65	0,67	8,0	5,0	1,6	1,6	WCR 16.../WCL 16...		
181157200	020E62090-02-U020220	2	20	20	19,7	220	193	70	0,87	10,0	6,0	2,0	2,0	WCR 20.../WCL 20...		
181157300	020E62090-02-U020250	2	20	20	19,7	250	223	70	1,00	10,0	6,0	2,0	2,0	WCR 20.../WCL 20...		
181157400	020E62090-02-U020300	2	20	20	19,7	300	273	70	1,23	10,0	6,0	2,0	2,0	WCR 20.../WCL 20...		

Stock item | Produto de stock | Itens de stock

Available under request | Disponível sobre consulta | Disponible bajo consulta



Threaded Steel Shank

Tolerance R	Runout Tolerance
± 0,015	R 0,02

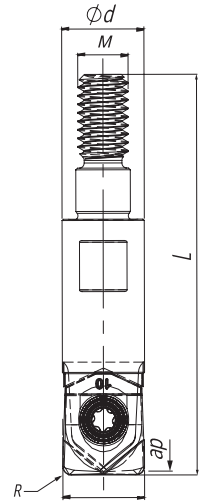

Order code Código	Reference Referência Referencia		Dimensions Dimensões Dimensiones (mm)					Kg	Specifications				Insert	Stock
			ØDc	R	Ød	L	M		A _p max (mm)		A _e max (mm)			
181167000	010R62090-02-UM06030	2	10	5	6,5	30	M6	0,011	5	3,0	1,0	1,0	WCR 10.../WCL 10...	
181167100	012R62090-02-UM06030	2	12	6	6,5	30	M6	0,016	6	4,0	1,2	1,2	WCR 12.../WCL 12...	
181167200	016R62090-02-UM08030	2	16	8	8,5	30	M8	0,028	8	5,0	1,6	1,6	WCR 16.../WCL 16...	
181167300	020R62090-02-UM10035	2	20	10	10,5	35	M10	0,058	10	6,0	2,0	2,0	WCR 20.../WCL 20...	

Stock item | Produto de stock | Itens de stock

Available under request | Disponível sobre consulta | Disponible bajo consulta

SPARE PARTS Complementos | Repuestos

Cutter ØDc	Insert Screw	Key (Torx)	Order separately	
			Key (Torx - Nm)	Torque Value
8	P0300726	XT08	DT0812	1,2
10	P0350825	XT10	DT1020	2,0
12	P0501025	XT20	DT2050	5,0
16	P0501326	XT20	DT2050	5,0
20	P0601725	XT25	-	6,9

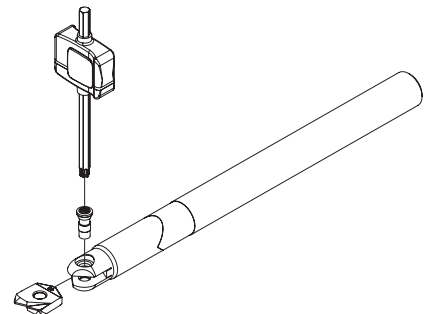



WCR | Inserts | Pastilhas | Plaquetas

WCR

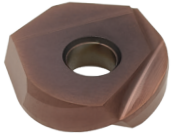

WCR

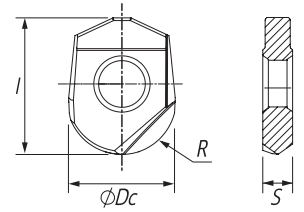

	⁽²⁾ Grade code	P		M		K		H		Dimensions Dimensões Dimensiones (mm)			
		PVD		PVD		PVD		PVD					
		⁽¹⁾ Geometry code	ISO Reference	X4	X6	X4	X6	X4	X6	X4	X6	I	R
		PHH603	PHH910	PHH603	PHH910	PHH603	PHH910	PHH603	PHH910				
1112900	WCR 08									9,7	4,0	2,1	8,0
1111914	WCR 10									12,0	5,0	2,7	10,0
1112099	WCR 12									14,6	6,0	3,2	12,0
1112100	WCR 16									16,6	8,0	4,2	16,0
1112101	WCR 20									20,0	10,0	5,2	20,0

First choice | Primeira opção | 1ª opción

Stock item | Produto de stock | Itens de stock

Available under request | Disponível sobre consulta | Disponible bajo consulta

Insert order code = (1) Geometry Code + (2) Grade Code

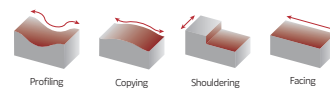

WCL | Inserts | Pastilhas | Plaquetas

WCL

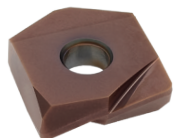

WCL

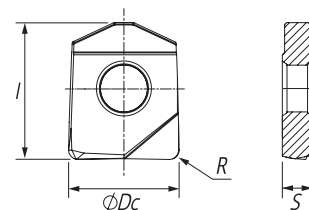



Geometry code	ISO Reference	P		M		K		H		Dimensions Dimensões Dimensiones (mm)			
		PVD		PVD		PVD		PVD					
		X4	X6	X4	X6	X4	X6	X4	X6	l	R	S	Dc
1112879	WCL-08 R0.3	⊗	⊗	⊗	⊗	⊗	⊗	⊗	⊗	9,7	0,3	2,1	8
1112880	WCL-08 R0.5	⊗	⊗	⊗	⊗	⊗	⊗	⊗	⊗	9,7	0,5	2,1	08
1112853	WCL-08 R1.0	⊗	⊗	⊗	⊗	⊗	⊗	⊗	⊗	9,7	1,0	2,1	08
1112881	WCL-10 R0.3	⊗	⊗	⊗	⊗	⊗	⊗	⊗	⊗	12,0	0,3	2,7	10
1112882	WCL-10 R0.5	⊗	⊗	⊗	⊗	⊗	⊗	⊗	⊗	12,0	0,5	2,7	10
1112848	WCL-10 R1.0	⊗	⊗	⊗	⊗	⊗	⊗	⊗	⊗	12,0	1,0	2,7	10
1112883	WCL-10 R1.5	⊗	⊗	⊗	⊗	⊗	⊗	⊗	⊗	12,0	1,5	2,7	10
1112884	WCL-10 R2.0	⊗	⊗	⊗	⊗	⊗	⊗	⊗	⊗	12,0	2,0	2,7	10
1112885	WCL-12 R0.3	⊗	⊗	⊗	⊗	⊗	⊗	⊗	⊗	14,6	0,3	3,2	12
1112886	WCL-12 R0.5	⊗	⊗	⊗	⊗	⊗	⊗	⊗	⊗	14,6	0,5	3,2	12
1112096	WCL-12 R1.0	⊗	⊗	⊗	⊗	⊗	⊗	⊗	⊗	14,6	1,0	3,2	12
1112887	WCL-12 R1.5	⊗	⊗	⊗	⊗	⊗	⊗	⊗	⊗	14,6	1,5	3,2	12
1112888	WCL-12 R2.0	⊗	⊗	⊗	⊗	⊗	⊗	⊗	⊗	14,6	2,0	3,2	12
1112889	WCL-12 R3.0	⊗	⊗	⊗	⊗	⊗	⊗	⊗	⊗	14,6	3,0	3,2	12
1112890	WCL-16 R0.3	⊗	⊗	⊗	⊗	⊗	⊗	⊗	⊗	16,6	0,3	4,2	16
1112891	WCL-16 R0.5	⊗	⊗	⊗	⊗	⊗	⊗	⊗	⊗	16,6	0,5	4,2	16
1112097	WCL-16 R1.0	⊗	⊗	⊗	⊗	⊗	⊗	⊗	⊗	16,6	1,0	4,2	16
1112892	WCL-16 R1.5	⊗	⊗	⊗	⊗	⊗	⊗	⊗	⊗	16,6	1,5	4,2	16
1112893	WCL-16 R2.0	⊗	⊗	⊗	⊗	⊗	⊗	⊗	⊗	16,6	2,0	4,2	16
1112894	WCL-16 R3.0	⊗	⊗	⊗	⊗	⊗	⊗	⊗	⊗	16,6	3,0	4,2	16
1112895	WCL-20 R0.3	⊗	⊗	⊗	⊗	⊗	⊗	⊗	⊗	20,0	0,3	5,2	20
1112896	WCL-20 R0.5	⊗	⊗	⊗	⊗	⊗	⊗	⊗	⊗	20,0	0,5	5,2	20
1112098	WCL-20 R1.0	⊗	⊗	⊗	⊗	⊗	⊗	⊗	⊗	20,0	1,0	5,2	20
1112897	WCL-20 R1.5	⊗	⊗	⊗	⊗	⊗	⊗	⊗	⊗	20,0	1,5	5,2	20
1112898	WCL-20 R2.0	⊗	⊗	⊗	⊗	⊗	⊗	⊗	⊗	20,0	2,0	5,2	20
1112899	WCL-20 R3.0	⊗	⊗	⊗	⊗	⊗	⊗	⊗	⊗	20,0	3,0	5,2	20

⊗ First choice | Primeira opção | 1ª opción ⊗ Stock item | Produto de stock | Itens de stock ○ Available under request | Disponível sobre consulta | Disponible bajo consulta Insert order code = (1) Geometry Code + (2) Grade Code

GRADES SELECTION GUIDE | Guia para selecção de graus | Tabla para selección de calidades

ISO	PSM	Material	HB (Brinell)	Grades		
				← Wear Resistance		Toughness →
				PHH603	PHH910	
P	1	Unalloyed Steel	125-220	✓	✓	
	2	Low-Alloyed Steel	220-280	✓	✓	
	3	High-Alloyed Steel	280-380	✓	✓	
M	4	SS - Ferritic / Martensitic	200-330	✓	✓	
	5	SS - Austenitic	200-330	✓	✓	
	6	SS - Austenitic-ferritic (Duplex)	230-260	✓	✓	
K	7	Malleable Cast Iron	130-230	✓	✓	
	8	Grey Cast Iron	180-245	✓	✓	
	9	Nodular Cast iron	160-250	✓	✓	
H	12	Hardened Steels	40-55 HRC	✓	✓	

 Good Conditions
 Average Conditions
 Difficult Conditions

RECOMMENDED CUTTING CONDITIONS | Condições de corte recomendadas | Condiciones de corte recomendables

ISO	PSM	Material	HB (Brinell)	Vc (m/min)		Feed fz (mm/t)		
				← Wear Resistance		Toughness →		
				PHH603	PHH910	WCR	WCL	
P	1	Unalloyed Steel	125-220	180-310	140-270	0,15-0,45	0,10-0,30	
	2	Low-Alloyed Steel	220-280	180-300	140-260	0,15-0,40	0,10-0,25	
	3	High-Alloyed Steel	280-380	180-280	140-220	0,10-0,40	0,10-0,25	
M	4	SS - Ferritic / Martensitic	200-330	170-300	130-260	0,15-0,35	0,10-0,25	
	5	SS - Austenitic	200-330	160-290	120-250	0,15-0,35	0,10-0,25	
	6	SS - Austenitic-ferritic (Duplex)	230-260	150-270	110-230	0,15-0,30	0,08-0,20	
K	7	Malleable Cast Iron	130-230	200-380	180-370	0,10-0,50	0,10-0,35	
	8	Grey Cast Iron	180-245	180-360	180-350	0,10-0,45	0,10-0,30	
	9	Nodular Cast iron	160-250	160-310	160-290	0,10-0,40	0,10-0,30	
H	12	Hardened Steels	46-54 HRC	90-270	80-260	0,05-0,20	0,05-0,15	
	13	Hardened Steels	55-62 HRC	80-200	70-180	0,05-0,15	0,04-0,12	
	14	Hardened Steels	63-70 HRC	70-180	70-160	0,04-0,12	0,04-0,10	

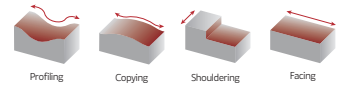

TEST REPORT || Relatório de teste | Informe de prueba

Insert: WCR - 16 PHH603

X155Cr-MoV12-1 (59 HRC)

Cutting speed: V_c	250 m/min
Feed per tooth: f_z	0,05 mm/tooth
Depth of cut: a_p	0,10 mm
Stepover : a_e	0,10 mm
Operation	Profiling / Copying
Coolant	No coolant

PALBIT

COMPETITOR

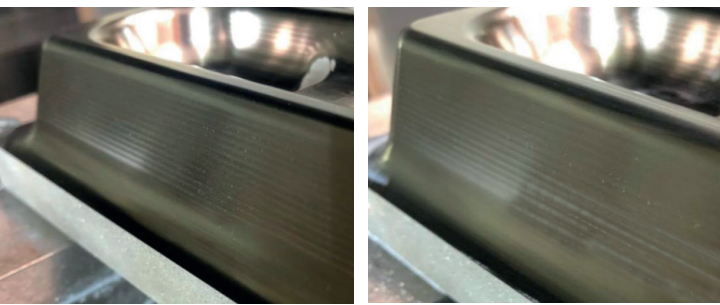
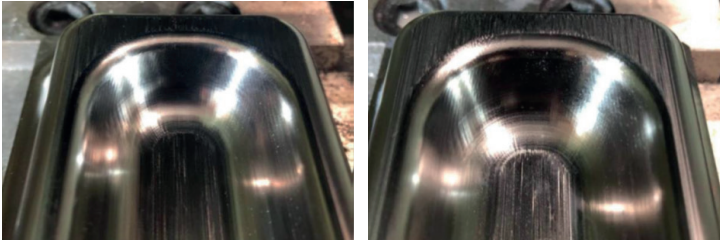

PALBIT AFTER 12H

COMPETITOR AFTER 12H

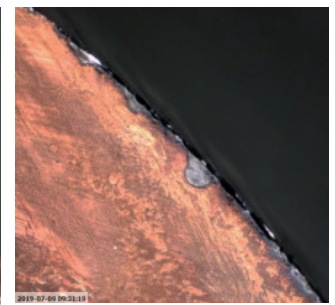
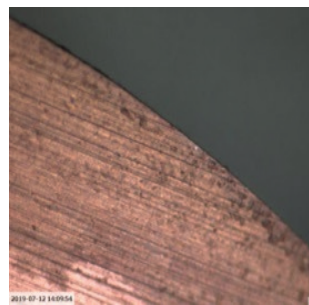

Insert: WCL - 16 R1.0 PHH603

X155Cr-MoV12-1 (59 HRC)

Cutting speed: V_c	100 m/min
Feed per tooth: f_z	0,05 mm/tooth
Depth of cut: a_p	0,25 mm
Stepover : a_e	0,25 mm
Operation	Side Milling
Coolant	No coolant

Side Milling

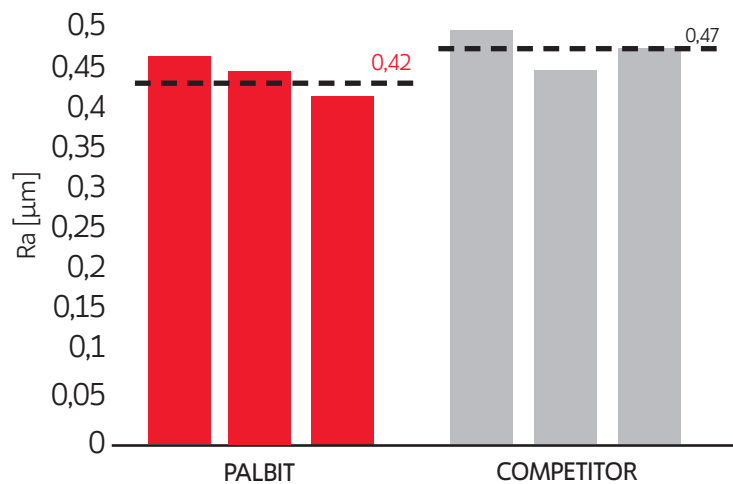
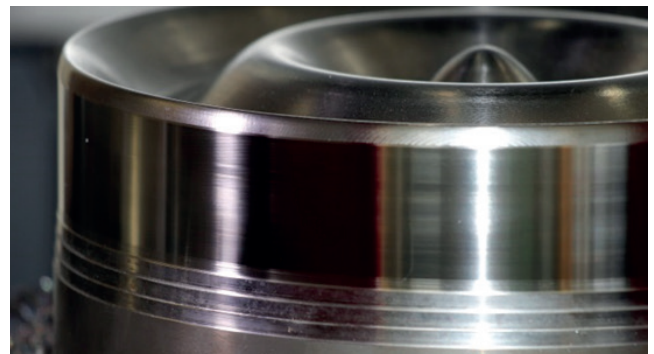

PALBIT AFTER 21H30

COMPETITOR AFTER 16H10

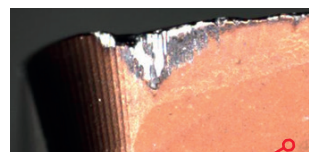
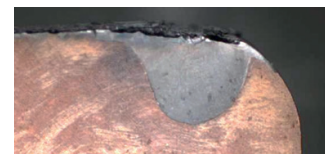

30%
TOOL LIFE
IMPROVEMENT

Surface finish after 10h45min



W-PRO
62090

NEW

HEADQUARTERS

PALBIT, S.A.

P.O.Box 4 - Palhal

3854-908 - Branca ALB - Portugal

T (+351) 234 540 300 | F (+351) 234 540 301

palbit@palbit.pt | www.palbit.pt

Branch office:

PALBIT México

Emerson 150. Int.803-804. Colonia Chapultepec

Morales Delagación Miguel Hidalgo

C.P. 11570 México DF

T (+52) 5555 454 543 | F (+52) 5552 509 190

info@palbit.com.mx | www.palbit.com.mx



SINCE 1916